

# Intersecting Two-Dimensional Fractals with Lines

Shigeki Akiyama

Department of Mathematics, Faculty of Science,  
Niigata University, Ikarashi 2-8050,  
Niigata 950-2181, Japan  
akiyama@math.sc.niigata-u.ac.jp

and

Klaus Scheicher

Johann Radon Institute for  
Computational and Applied Mathematics (RICAM),  
Austrian Academy of Sciences,  
Altenbergerstraße 69, A-4040 Linz, Austria  
klaus.scheicher@oeaw.ac.at

## *Abstract*

The Twin Dragon and Rauzy fractals are intersected with the real axis. In the Twin Dragon case, unexpectedly from its fractal nature, the intersection is an interval characterized by a finite automaton. For the case of the Rauzy fractal, it is proved that the intersection has infinitely many components.

## 1. INTRODUCTION

In the present paper, we shall study the intersection of certain plane fractals with lines, especially the first coordinate axis. The famous result due to J. M. Marstrand [33] reads that if a set  $X \subset \mathbb{R}^2$  has Hausdorff dimension  $d > 1$  and finite positive  $d$ -dimensional Hausdorff measure, then for almost all lines  $L$ , the Hausdorff dimension of  $X \cap L$  is  $d - 1$ . However, apart from metrical results like Marstrand's, the authors could not find nontrivial <sup>1</sup> examples on concrete fractals and lines in the literature.

In the sequel, we will prove some very concrete results on well known fractals such as the Twin Dragon  $\mathcal{F}$  and Rauzy-Thurston fractal  $\mathcal{T}$ . Readers shall find unexpected 'rational' phenomena in these fractals.

The method employed for the Twin Dragon  $\mathcal{F}$  is to introduce a finite automaton to describe its intersection. This method essentially relies on the fact that  $\mathcal{F}$  has a self similar structure with 'rational times  $\pi$ ' angle. It implies that the intersection with the real axis is an interval (Theorem 2.9). Furthermore, the real line intersects with its boundary  $\partial\mathcal{F}$  only in two points (Theorem 2.12). This is quite unexpected from its fractal nature. From [28] follows, that  $\dim_{\text{H}} \partial\mathcal{F} = 2 \log \lambda / \log 2 = 1.523627\dots$ , where  $\lambda$  is the real root of  $\lambda^3 - \lambda^2 - 2 = 0$ . Therefore, the real line is exceptional in the sense of the Marstrand result.

For a Rauzy-Thurston fractal  $\mathcal{T}$ , we will show firstly that the largest negative real point on the boundary is very close to  $-2/3$  (Theorem 3.1). We use the graph directed self similar structure of the boundary to show this. This method of computation should be applicable to a rather big class of attractors. Moreover we will show that the intersection with the negative real axis has infinitely many components (Theorem 3.9). To prove this, we use the special structure of this fractal set. The idea is to find a contractive map around  $-1$  which preserves the local structure. We expect results of similar type for the Rauzy-Thurston fractal corresponding to cubic Pisot units having complex conjugates.

These results have some applications for purely periodic expansions (Theorem 2.16, 3.5, 3.10).

## 2. THE TWIN DRAGON AND THE COORDINATE AXES

First we review some definitions and known results on canonical number systems.

**Definition 2.1.** *Let  $P(x) = b_n x^n + b_{n-1} x^{n-1} + \dots + b_0 \in \mathbb{Z}[x]$  be such that  $n \geq 1$  and  $b_n = 1$ . Let  $\mathcal{R} = \mathbb{Z}[x]/P(x)\mathbb{Z}[x]$ . Then each  $\gamma \in \mathcal{R}$  can be represented uniquely as*

$$\gamma = g_0 + g_1 x + \dots + g_{n-1} x^{n-1}$$

*with  $g_i \in \mathbb{Z}$ .*

---

<sup>1</sup>Occasionally the problem becomes trivial. For instance, the intersection of the Sierpinski Gasket and a horizontal line which touches the boundary is an interval.

Let  $\mathcal{N} = \{0, 1, \dots, |b_0| - 1\}$ . The pair  $(P(x), \mathcal{N})$  is called a canonical number system in  $\mathcal{R}$  (for short CNS), if each  $\gamma \in \mathcal{R}$  admits a unique representation

$$(2.1) \quad \gamma = d_0 + d_1x + \dots + d_{h-1}x^{h-1}$$

with  $d_i \in \mathcal{N}$ ,  $d_{h-1} \neq 0$  and  $d_i = 0$  for  $i \geq h$ . In this case,  $P(x)$  is called a CNS polynomial. The number  $h$  is called the length of the representation.

If  $P(x)$  is irreducible, then let  $\alpha$  be one of its zeros. In this case  $\mathcal{R}$  is isomorphic to  $\mathbb{Z}[\alpha]$ , the Ring generated by  $\mathbb{Z}$  and  $\alpha$ . Therefore we may replace  $x$  by  $\alpha$  in the above expansions. In this case, we simplify the notation  $(P(x), \mathcal{N})$  to  $(\alpha, \mathcal{N})$  and  $\alpha$  is called base of this CNS.

This setting provides a natural generalization of the ordinary  $b$ -ary number systems in  $\mathbb{N}$ . In the ordinary case, it is clear that each integer  $b \geq 2$  can serve as a base. The CNS case, however, seems to be much more complicated. Despite the fact that there has been much research on this topic, a complete characterization of all CNS polynomials still does not exist. Quadratic CNS have been completely characterized in a series of papers by Gilbert, Kátai, Kovács and Szabó (cf. [20, 26, 27, 28]).

However, already the cubic case is quite difficult. In a recent paper, Akiyama et al. [4] proved several results for special cubic polynomials. For higher degrees, there exist characterization results for polynomials with descending coefficients (cf. Kovács-Pethő [29]) or with large  $b_0$  (cf. Akiyama-Pethő [6], Akiyama-Rao [7] and Scheicher-Thuswaldner [39]). Finally we want to mention that Brunotte [16, 15] characterized CNS for trinomials. Brunotte also provided the fastest currently known algorithm to determine if an arbitrary polynomial is CNS or not. A recent survey on CNS is given in [3].

CNS are intimately related to tilings. Following [34, 37], we define the fundamental domain of  $(P(x), \mathcal{N})$ . Let  $\alpha^{(i)}$  be the zeros of  $P(x)$ , ordered in a way such that  $\alpha^{(i)}$ ,  $i = 1, \dots, r_1$  are real and  $\alpha^{(i)}$ ,  $i = r_1 + 1, \dots, r_1 + 2r_2 = n$  are complex with

$$\begin{aligned} \alpha^{(r_1+2j-1)} &= \overline{\alpha^{(r_1+2j)}} \\ \Im \alpha^{(r_1+2j-1)} &= -\Im \alpha^{(r_1+2j)} > 0 \end{aligned}$$

for  $j = 1, \dots, r_2$ . In order to exclude trivial cases, we will assume that all  $\alpha^{(i)}$  are different. Kovács-Pethő [29] remarked that  $P(x)$  can be a CNS polynomial only if  $|\alpha^{(i)}| > 1$  for all  $i \in \{1, \dots, n\}$ . In this case,  $P(x)$  is called expanding.

Consider the embeddings  $\Phi^{(i)} : \mathcal{R} \mapsto \mathbb{Q}(\alpha^{(i)})$ ,  $1 \leq i \leq n$  such that

$$\sum_{j=0}^{n-1} g_j x^j \mapsto \sum_{j=0}^{n-1} g_j (\alpha^{(i)})^j.$$

Then we can define an embedding  $\Phi : \mathcal{R} \mapsto \mathbb{R}^n$  by

$$(2.2) \quad \Phi := (\Phi^{(1)}, \dots, \Phi^{(r_1)}, \Re \Phi^{(r_1+1)}, \Im \Phi^{(r_1+1)}, \dots, \Re \Phi^{(r_1+2r_2-1)}, \Im \Phi^{(r_1+2r_2-1)})^T.$$

From (2.2), it follows that

$$\Phi(x\gamma) = B\Phi(\gamma)$$

for each  $\gamma \in \mathcal{R}$  where

$$B := \text{diag}(\alpha^{(1)}, \dots, \alpha^{(r_1)}, A^{(1)}, \dots, A^{(r_2)})$$

and

$$A^{(j)} = \begin{pmatrix} \Re\alpha^{(r_1+2j-1)} & -\Im\alpha^{(r_1+2j-1)} \\ \Im\alpha^{(r_1+2j-1)} & \Re\alpha^{(r_1+2j-1)} \end{pmatrix}.$$

The fundamental domain  $\mathcal{F}$  of  $(P(x), \mathcal{N})$  is defined by

$$(2.3) \quad B\mathcal{F} = \bigcup_{d \in \mathcal{N}} (\mathcal{F} + \Phi(d))$$

which is equivalent to

$$(2.4) \quad \mathcal{F} = \left\{ \sum_{i=1}^{\infty} B^{-i} \Phi(d_i) : d_i \in \mathcal{N} \right\}.$$

It was shown in Kátai-Környei [25] that the set

$$\mathcal{F} + \mathbb{Z}^n$$

forms a tiling of  $\mathbb{R}^n$ . Let

$$S := \{s \in \mathbb{Z}^n \setminus \{0\} : \mathcal{F} \cap (\mathcal{F} + s) \neq \emptyset\}$$

and

$$\mathcal{F}_s := \mathcal{F} \cap (\mathcal{F} + s), \quad \text{for } s \in S.$$

Since  $\mathcal{F}$  is compact,  $S$  is finite. Following [17] the boundary of  $\mathcal{F}$  is given by

$$\partial\mathcal{F} = \bigcup_{s \in S} \mathcal{F}_s.$$

$\mathcal{F}$  and  $\partial\mathcal{F}$  have been studied in several papers. Topological properties for quadratic CNS are given in [10, 9, 5].

For quadratic polynomials  $P(x)$  with imaginary roots, we have that  $|\alpha^{(1)}| = |\alpha^{(2)}|$ , and therefore,  $\mathcal{F}$  is a self similar set. In this case, the Hausdorff dimension of  $\partial\mathcal{F}$  has been computed in [34].

In general, when not all  $\alpha^{(i)}$  are equal in modulus,  $\mathcal{F}$  is self affine rather than self similar. This case is much harder to deal with. For  $1 = b_n < b_{n-1} < \dots < b_0$ , the box counting dimension of  $\partial\mathcal{F}$  has been computed in [37, 38].

**Theorem 2.2.** *Assume that  $P(x)$  is irreducible and  $(\alpha, \mathcal{N})$  is a CNS. Let  $\gamma \in \mathbb{Q}(\alpha)$  such that*

$$\gamma = \frac{g_0 + g_1\alpha + \dots + g_{n-1}\alpha^{n-1}}{q}$$

with  $g_0, \dots, g_{n-1}, q \in \mathbb{Z}$ . If  $\gamma$  is an inner point of  $\mathcal{F}$  and  $q$  is coprime to  $b_0$ , then  $\gamma$  has a purely periodic expansion

$$(2.5) \quad \gamma = \frac{\sum_{i=1}^{\ell} d_i \alpha^{-i}}{1 - \alpha^{-\ell}} = \frac{d_1}{\alpha} + \frac{d_2}{\alpha^2} + \dots + \frac{d_{\ell}}{\alpha^{\ell}} + \frac{d_1}{\alpha^{\ell+1}} + \dots + \frac{d_{\ell}}{\alpha^{2\ell}} + \dots,$$

for some positive integer  $\ell$  and  $d_i \in \mathcal{N}$ .

**Remark 2.3.** This result is the analogue of the fact that every  $x \in \mathbb{Q} \cap (0, 1)$  which has a denominator coprime to 10 is purely periodic in decimal base (cf. Hardy-Wright [23, Theorem 135.]).

**Remark 2.4.** By the notation  $\gamma = .d_1 d_2 \dots$ , we express an expansion of the form  $\gamma = \sum_{i=1}^{\infty} d_i \alpha^{-i}$  and by  $.[d_1 d_2 d_3 \dots d_{\ell}]^{\infty}$  a periodic expansion as above. The expansion in (2.1) is unique but the infinite expansions like (2.5) are not necessary unique.

*Proof.* Take an integer  $q$  coprime to  $b_0$  such that  $q\gamma \in \mathbb{Z}[\alpha]$ . We claim that  $\alpha \pmod{q\mathbb{Z}[\alpha]}$  is a unit in the finite ring  $\mathbb{Z}[\alpha]/q\mathbb{Z}[\alpha]$ . Let  $\beta = b_0/\alpha$ . Then  $\beta = -(b_1 + b_2\alpha + \dots + b_n\alpha^{n-1}) \in \mathbb{Z}[\alpha]$  and  $\alpha\beta = b_0$ . There exists a positive integer  $i$  such that  $b_0^i \equiv 1 \pmod{q\mathbb{Z}}$ . This proves the claim.

We see that  $\alpha^m \equiv 1 \pmod{q\mathbb{Z}[\alpha]}$  for some  $m$ , since  $\alpha$  belongs to the unit group of the finite ring  $\mathbb{Z}[\alpha]/q\mathbb{Z}[\alpha]$ . Therefore  $(\alpha^m - 1)\gamma = ((\alpha^m - 1)/q)q\gamma$  belongs to  $\mathbb{Z}[\alpha]$ . Note that  $m$  can be replaced by its multiple. Since  $(\alpha, \mathcal{N})$  is a CNS, we have  $(\alpha^m - 1)\gamma = \sum_{i=0}^{\ell} d_i \alpha^i$  for some  $\ell$ . If  $\ell < m$ , then we already get the desired expression. If not, take  $2m, 3m, \dots$ . Then we get expressions

$$\gamma = \frac{\sum_{i=1}^{\ell_k} d_i^{(k)} \alpha^{i-km}}{1 - \alpha^{-km}}, \quad \text{for } k = 1, 2, \dots$$

Assume that  $\ell_k \geq km$  for all  $k$ . As  $1 - \alpha^{-km} \rightarrow 1$ , we get a sequence

$$y_k = \sum_{i=1}^{\ell_k} d_i^{(k)} \alpha^{i-km}$$

which converges to  $\gamma$ . Since  $y_k \in \mathcal{F} + \sum_{i=km}^{\ell_k} d_i^{(k)} \alpha^{i-km}$ , we see that  $y_k$  is contained in a translation of  $\mathcal{F}$  which is not  $\mathcal{F}$  itself. Recall that  $\mathbb{R}^d$  is tiled by  $\mathcal{F}$  and it translates

$$\mathbb{R}^d = \bigcup_{z \in \mathbb{Z}[\alpha]} \mathcal{F} + \Phi(z)$$

and the interior of  $\mathcal{F}$  does not intersect  $\mathcal{F} + \Phi(z)$  for  $z \in \mathbb{Z}[\alpha] \setminus \{0\}$ . Thus  $\gamma$  can not be an inner point of  $\mathcal{F}$ .  $\square$

**Remark 2.5.** As  $|\alpha^{(i)}| > 1$  for all  $i \in \{1, \dots, n\}$ , the convergence of the right hand side of (2.5) is valid in the image of any conjugate map  $\Phi^{(i)} : \mathcal{R} \mapsto \mathbb{Q}(\alpha^{(i)})$  and therefore also in the image of  $\Phi$ .

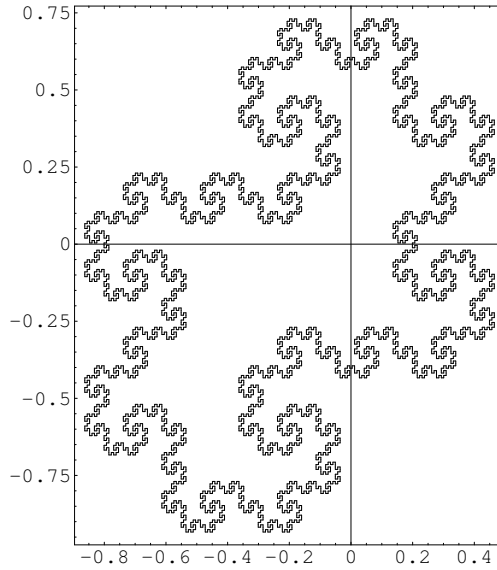

FIGURE 1. The boundary  $\partial\mathcal{F}$  of the Twin Dragon.

In remainder of this section, we deal with the polynomial  $P(x) = x^2 + 2x + 2$ . In this case,  $\mathcal{F}$  is the famous Twin Dragon fractal (cf. Mandelbrot [32]). Its boundary is shown in Figure 1.

**Definition 2.6.** (cf. [11, 18, 30]). *The 5-tuple  $\mathcal{A} = (Q, A, E, I, T)$  is called a finite automaton if*

- $Q$  and  $A$  are nonempty, finite sets,
- $E \subset Q \times A \times Q$  and
- $I, T \subset Q$ .

The set  $Q = \{q_1, \dots, q_N\}$  is called the set of the states,  $A$  is called the input alphabet.  $E$  is called the set of edges. The sets  $I$  and  $T$  are called initial and terminal states, respectively.

A finite automaton works as follows. The automaton starts at time 1 in the state  $q_{i_1} \in I$ . At each discrete time  $n \geq 1$ , the automaton reads an input digit  $\ell_n$ . If  $(q_{i_n}, \ell_n, q_{i_{n+1}}) \in E$ , the next state is  $q_{i_{n+1}}$ . We will denote this with

$$q_{i_n} \xrightarrow{\ell} q_{i_{n+1}}.$$

A finite path of length  $n - 1$  is a sequence

$$q_{i_1} \xrightarrow{\ell_1} q_{i_2} \xrightarrow{\ell_2} q_{i_3} \cdots q_{i_{n-1}} \xrightarrow{\ell_{n-1}} q_{i_n}$$

of consecutive edges. Its label is the word  $\ell_1\ell_2 \cdots \ell_{n-1}$ . For short, we will denote this with  $q_{i_1} \xrightarrow{\ell} q_{i_n}$ . A finite path  $q_{i_1} \xrightarrow{\ell} q_{i_n}$  is successful if it starts in an initial

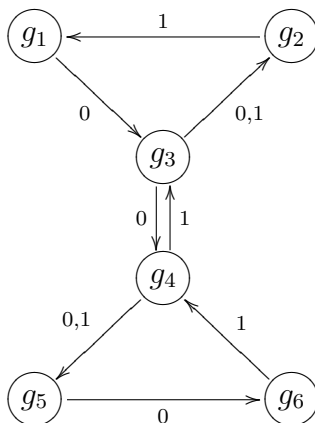

FIGURE 2. The automaton  $\mathcal{G}$  characterizing  $\partial\mathcal{F}$ .

state and ends in a terminal state. An infinite path  $q_{i_1} \xrightarrow{\ell_1} q_{i_2} \xrightarrow{\ell_2} q_{i_3} \cdots$  is successful if there are infinitely many  $n$  such that  $q_{i_1} \xrightarrow{\ell} q_{i_n}$  is successful. The set recognized by  $\mathcal{A}$  is the set of labels of its successful paths.

The boundary  $\partial\mathcal{F}$  is closely related to a finite automaton  $\mathcal{G}$  which is described, for example, in [21]. Originally,  $\mathcal{G}$  was defined in a slightly different way. Namely, its edges were directed in the opposite direction. This was due to the fact, that  $\mathcal{G}$  was interpreted as adding machine in that paper. Since we are not concerned with this interpretation, we direct the edges in the same way as Müller et al. [34]. So its adjacency matrix coincides with the matrices used in Duvall et al. [17], Gröchenig-Haas [22], Wang [43] and many other papers. In [10, 34] the following result has been proved:

**Proposition 2.7.** *The boundary  $\partial\mathcal{F}$  can be recognized by the finite automaton  $\mathcal{G}$  which is shown in Figure 2. Let  $Q_{\mathcal{G}} = \{g_1, \dots, g_6\}$  be the set of states of  $\mathcal{G}$ . Let  $I_{\mathcal{G}}$  and  $T_{\mathcal{G}}$  be the sets of initial and terminal states respectively. Then  $I_{\mathcal{G}} = T_{\mathcal{G}} = Q_{\mathcal{G}}$ .  $\partial\mathcal{F}$  consists of six curve segments and  $x \in \mathcal{F}_s$  if and only of*

$$x = \sum_{i=1}^{\infty} B^{-i} \Phi(d_i)$$

where  $s = g_{j_1}$  is a starting state and

$$g_{j_1} \xrightarrow{d_1} g_{j_2} \xrightarrow{d_2} g_{j_3} \cdots$$

is an infinite successful path in  $\mathcal{G}$ .

Let  $X_1 = \{(x_1, 0) : x_1 \in \mathbb{R}\}$  and  $X_2 = \{(0, x_2) : x_2 \in \mathbb{R}\}$ .

**Proposition 2.8.** *The intersections  $\mathcal{F} \cap X_1$  and  $\mathcal{F} \cap X_2$  can be recognized by the finite automaton  $\mathcal{H}$  which is shown in Figure 3. Let  $Q_{\mathcal{H}} = \{h_1, \dots, h_5\}$  be the set*

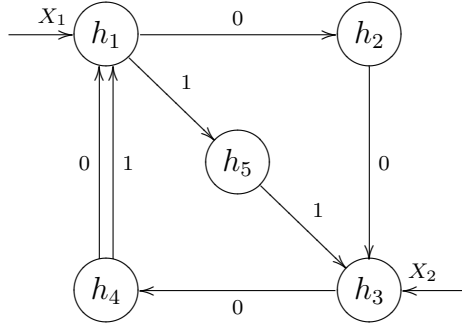

FIGURE 3. The automaton  $\mathcal{H}$  characterizing  $\mathcal{F} \cap X_1$  and  $\mathcal{F} \cap X_2$ .

of states of  $\mathcal{H}$ . The sets of initial and terminal states are given by  $I_{\mathcal{H}} = \{h_1, h_3\}$  and  $T_{\mathcal{H}} = \{h_1, \dots, h_4\}$ . We have  $x \in \mathcal{F} \cap X_1$ , ( $x \in \mathcal{F} \cap X_2$ ) if and only if

$$x = \sum_{i=1}^{\infty} B^{-i} \Phi(d_i)$$

where  $h = h_{k_1}$  is a starting state and

$$h_{k_1} \xrightarrow{d_1} h_{k_2} \xrightarrow{d_2} h_{k_3} \cdots$$

is an infinite successful path in  $\mathcal{H}$ . The starting state  $h_{k_1}$  is either  $h_1$  for  $\mathcal{F} \cap X_1$  or  $h_3$  for  $\mathcal{F} \cap X_2$ .

*Proof.* Since  $P(x) = x^2 + 2x + 2$ , it follows that  $\alpha^{(i)} = -1 \pm \sqrt{-1}$  and

$$B = \begin{pmatrix} -1 & -1 \\ 1 & -1 \end{pmatrix}.$$

Since

$$(2.6) \quad \Phi(d_i) = (d_i, 0)^T$$

for all  $d_i \in \mathcal{N}$ , equation (2.4) can be considered as a product

$$x = C \cdot d$$

of a matrix  $C \in \mathbb{R}^{2 \times \infty}$  with an infinitely long column vector  $d = (d_1, d_2, \dots)^T \in \mathbb{R}^{\infty}$ . With this notation

$$(2.7) \quad C = \begin{pmatrix} -\frac{1}{2} & 0 & \frac{1}{4} & -\frac{1}{4} & \frac{1}{8} & 0 & -\frac{1}{16} & \frac{1}{16} & \cdots \\ -\frac{1}{2} & \frac{1}{2} & -\frac{1}{4} & 0 & \frac{1}{8} & -\frac{1}{8} & \frac{1}{16} & 0 & \cdots \end{pmatrix}.$$

Equation (2.6) implies, that the  $i$ -th column of  $C$  is given by the first column of  $B^{-i}$ . Let  $c_{ij}$  denote the entries of  $C$ . From

$$(2.8) \quad B^{-8} = \begin{pmatrix} \frac{1}{16} & 0 \\ 0 & \frac{1}{16} \end{pmatrix}$$



follows

$$c_{i,j+8} = \frac{1}{16} c_{ij} \quad \text{for } i = 1, 2 \quad \text{and } j \geq 1.$$

For instance, if  $d_1 = 1$  then  $d_1\alpha^{-1}$  gives a contribution of  $-1/2$  in the direction of the imaginary axis. To come back to the real axis,  $d_2$  must be 1 since the sum of the remaining positive contributions are

$$\frac{1}{8} + \frac{1}{16} + \cdots < \frac{1}{2}.$$

In a similar manner one can easily see that the only choices for  $(d_1, d_2, \dots)^T$  such that  $x \in X_1$ , ( $x \in X_2$ ) are those which correspond to the infinite successful paths in  $\mathcal{H}$ . Conversely an infinite successful path clearly gives a point on  $\mathbb{R}$ . □

**Theorem 2.9.** *The intersection  $\mathcal{F} \cap X_1$  consists of the line segment  $\{(x_1, 0) : x_1 \in [-\frac{4}{5}, \frac{1}{5}]\}$ . The intersection  $\mathcal{F} \cap X_2$  consists of the line segment  $\{(0, x_2) : x_2 \in [-\frac{2}{5}, \frac{3}{5}]\}$ .*

*Proof.* Consider an infinite successful path

$$h_{k_1} \xrightarrow{d_1} h_{k_2} \xrightarrow{d_2} h_{k_3} \cdots$$

in  $\mathcal{H}$ . The sequence of labels corresponds to the digit expansion  $.d_1d_2d_2\dots$  of

$$\sum_{i=1}^{\infty} B^{-i} \Phi(d_i) = \sum_{j=1}^{\infty} \left( \sum_{k=1}^8 B^{8-k} \Phi(d_{8(j-1)+k}) \right) B^{-8j}.$$

Therefore, each block of eight digits can be regarded as a single digit for the base  $B^{-8}$  and each such block corresponds to a path in  $\mathcal{H}$  of length eight.

Looking at Figure 3, we see that a possible path of length eight must pass each of  $h_1$  and  $h_4$  twice. There are two edges leading out of  $h_1$  and  $h_4$  and there is only one edge leading out of  $h_2$ ,  $h_3$  and  $h_5$ . Therefore, for each  $h_{k_1}$  there are  $2^4 = 16$  paths of length eight starting in  $h_{k_1}$ .

Starting with  $h_{k_1} = h_1$ , we get the words

$$\begin{aligned} &00000000, 00000001, 00001100, 00001101, \\ &00010000, 00010001, 00011100, 00011101, \\ &11000000, 11000001, 11001100, 11001101, \\ &11010000, 11010001, 11011100, 11011101. \end{aligned}$$

These sixteen words correspond to the set of digit vectors

$$\{(-12, 0)^T, \dots, (3, 0)^T\}.$$

Since each number of  $[-\frac{4}{5}, \frac{1}{5}]$  can be expanded in base 16 with digits from  $\{-12, \dots, 3\}$ , we are done.

The same procedure works for  $X_2$ . Starting with  $h_{k_1} = h_3$ , we obtain the set of digit vectors

$$\{(0, -6)^T, \dots, (0, 9)^T\}.$$

It is also obvious that each number from  $[-\frac{2}{5}, \frac{3}{5}]$  can be expanded in base 16 with digits from  $\{-6, \dots, 9\}$ .  $\square$

**Remark 2.10.** Analogously to the decimal expansion of numbers from  $[0, 1]$ , the above expansions are not unique. For example, each of the expansions  $0.0[3]^\infty$  and  $0.1[-12]^\infty$  represent the value  $1/80$ . Nevertheless,  $\mathcal{H}$  accepts both expansions.

**Remark 2.11.** After we have proved that the intersections  $\mathcal{F} \cap X_i$  are intervals, there still exists the possibility that the boundary  $\partial\mathcal{F}$  is touching the  $X_i$  in some inner point of these intervals. We shall exclude this possibility by the next theorem.

**Theorem 2.12.** *The intersection  $\partial\mathcal{F} \cap X_1$  consists of the points  $(-\frac{4}{5}, 0)$  and  $(\frac{1}{5}, 0)$ . The intersection  $\partial\mathcal{F} \cap X_2$  consists of the points  $(0, -\frac{2}{5})$  and  $(0, \frac{3}{5})$ .*

*Proof.* A point  $x$  belongs to the intersection  $\partial\mathcal{F} \cap X_1$  if and only if it fulfills the criteria of the Propositions 2.7 and 2.8. Therefore, we can construct a product automaton  $\mathcal{G} \times \mathcal{H}$  which recognizes the intersection. The states are given by  $Q_{\mathcal{G} \times \mathcal{H}} = Q_{\mathcal{G}} \times Q_{\mathcal{H}}$ . The initial and terminal states are given by  $I_{\mathcal{G} \times \mathcal{H}} = I_{\mathcal{G}} \times I_{\mathcal{H}}$  and  $T_{\mathcal{G} \times \mathcal{H}} = T_{\mathcal{G}} \times T_{\mathcal{H}}$ . There is an edge  $(g, h) \xrightarrow{d} (g', h')$  in  $\mathcal{G} \times \mathcal{H}$  if and only if there are edges  $g \xrightarrow{d} g'$  in  $\mathcal{G}$  and  $h \xrightarrow{d} h'$  in  $\mathcal{H}$ . The intersection  $\mathcal{F} \cap X_1$  or  $\mathcal{F} \cap X_2$  is recognized by  $\mathcal{G} \times \mathcal{H}$  with initial states  $\{(g_{j_1}, h_1) : g_{j_1} \in Q_{\mathcal{G}}\}$  or  $\{(g_{j_1}, h_3) : g_{j_1} \in Q_{\mathcal{G}}\}$ .

Now one can see that there are only two infinite successful paths starting in a state  $(g_{j_1}, h_1)$  with  $g_{j_1} \in Q_{\mathcal{G}}$ . By starting in  $(g_1, h_1)$  and entering the digits  $.[00001101]^\infty$ , the infinite path

$$\begin{array}{cccccccc} (g_1, h_1) & \xrightarrow{0} & (g_3, h_2) & \xrightarrow{0} & (g_4, h_3) & \xrightarrow{0} & (g_5, h_4) & \xrightarrow{0} \\ (g_6, h_1) & \xrightarrow{1} & (g_4, h_5) & \xrightarrow{1} & (g_3, h_3) & \xrightarrow{0} & (g_2, h_4) & \xrightarrow{1} \\ (g_1, h_1) & \xrightarrow{0} & \dots & & & & & \end{array}$$

is passed. Looking on (2.7) and (2.8), this corresponds to the sum

$$\left(\frac{1}{8} + \frac{1}{16}\right) \left(1 + \frac{1}{16} + \frac{1}{16^2} + \dots\right) = \frac{1}{5}.$$

By starting in  $(g_6, h_1)$  and entering  $.[11010000]^\infty$ , the minimal value

$$\left(-\frac{1}{2} - \frac{1}{4}\right) \left(1 + \frac{1}{16} + \frac{1}{16^2} + \dots\right) = -\frac{4}{5}$$

is obtained.

The same idea can be applied for  $X_2$ . By starting in  $(g_4, h_3)$  and entering  $.[00110100]^\infty$ , the minimum of  $-\frac{2}{5}$  is obtained. By starting in  $(g_3, h_3)$  and entering  $.[01000011]^\infty$ , the maximum of  $\frac{3}{5}$  is obtained.  $\square$

**Remark 2.13.** Since the origin is an inner point (cf. [10]), by considering the maximal interval neighborhood of 0 in  $\mathcal{F} \cap X_i$ , it is easy to show that  $\mathcal{F} \cap X_i$  are intervals only by using the result without Theorem 2.9.

**Remark 2.14.** The fact that  $X_1 \cap \mathcal{F} = [-\frac{4}{5}, \frac{1}{5}]$  can also be proved from the fact that the intersection can be written as a graph-directed self affine subset of  $\mathbb{R}$  naturally constructed by the automaton given by the Figure 3. However, this technique does not provide information on the boundary points.

**Remark 2.15.** The automaton  $\mathcal{H}$  can only decide if  $x \in X_i$ ,  $i = 1, 2$ .  $\mathcal{H}$  can be extended to an automaton  $\overline{\mathcal{H}}$  which is able to determine the halfplane, if it turns out that  $x \notin X_i$ .  $\overline{\mathcal{H}}$  is shown in Figure 4.

Let  $x = (x_1, x_2)^T$ . The initial states of  $\overline{\mathcal{H}}$  are indicated by the corresponding flags.

Therefore, the terminal states of  $\overline{\mathcal{H}}$  are all states which are signed with a zero. Again, the points of  $X_i$  correspond to the infinite successful paths in  $\overline{\mathcal{H}}$ . All other paths (i.e. all paths which are running into a sink) correspond to points in the half planes. The sign of the half plane is given by the sign of the sink.

**Theorem 2.16.** *Let  $\gamma$  be a rational number with an odd denominator. Then  $\gamma$  has a purely periodic expansion in base  $-1 + \sqrt{-1}$  in the sense of Theorem 2.2 if and only if  $\gamma \in [-4/5, 1/5]$ .*

*Proof.* If  $\gamma$  has a purely periodic expansion, then  $\Phi(\gamma) \in \mathcal{F}$ . It follows by Theorem 2.2, that if  $\gamma$  has a purely periodic expansion then  $\gamma \in [-4/5, 1/5]$ .

Further if  $\gamma \in (-4/5, 1/5)$  then  $\Phi(\gamma)$  is an inner point of  $\mathcal{F}$  since we have already shown in the proof of the Theorem 2.9 that  $\gamma$  can not be on the boundary. Thus  $\gamma$  has a purely periodic expansion by Theorem 2.2. The only remaining thing to note is that  $1/5$  and  $-4/5$  have purely periodic expansions:

$$\frac{1}{5} = \frac{\alpha^3 + \alpha^2 + 1}{\alpha^8 - 1} = .[00001101]^\infty$$

and

$$-\frac{4}{5} = \frac{\alpha^7 + \alpha^6 + \alpha^4}{\alpha^8 - 1} = .[11010000]^\infty.$$

□

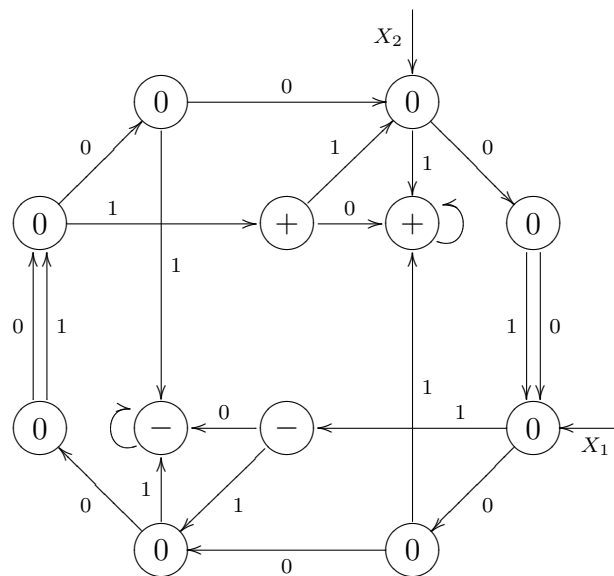

FIGURE 4. The extended automaton  $\overline{\mathcal{H}}$  for the half planes.

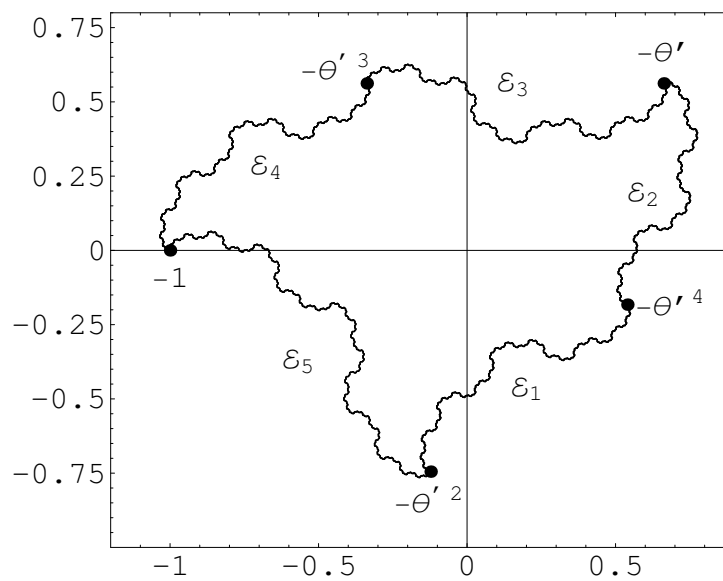
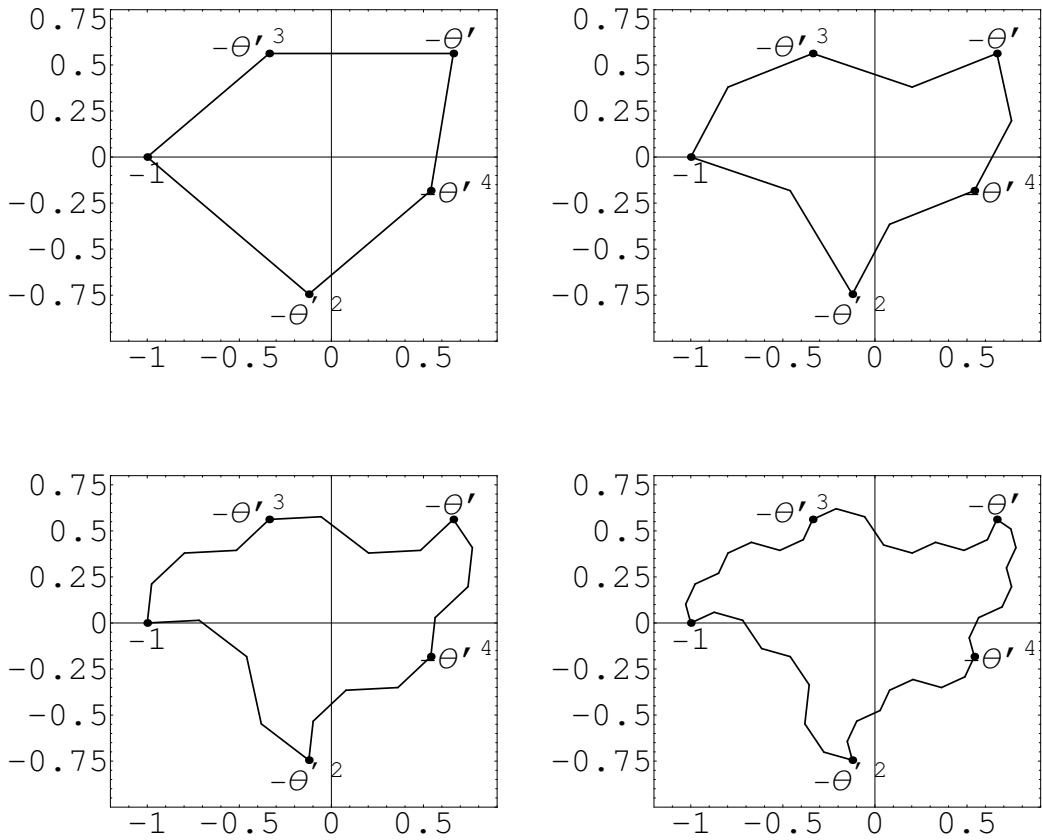

FIGURE 5. The boundary  $\partial\mathcal{T}$  of the minimal Pisot tile.

### 3. THE MINIMAL PISOT TILE AND THE REAL AXIS

FIGURE 6. The construction algorithm for  $\partial\mathcal{T}$ .

**3.1. Definition and Construction.** In the previous section, we have described the intersection of the Twin Dragon and the coordinate axes. It is natural to ask for some generalizations to arbitrary matrices  $B$ . Unfortunately, as the reader will soon notice, this is not an easy task. We mainly used the fact that there exists an integer  $n$  such that  $B^n$  is a scalar multiple of the identity matrix ( $n = 8$ ). If there is no such  $n$ , then it is perhaps impossible to find such a finite automaton. Even so, we wish to know the intersection as it may have many applications.

Nevertheless, there are some ways to approximate the intersection with the help of a computer. In this section we describe how an actual algorithm looks like by an example using another type of fractal set which corresponds to the minimal Pisot number  $\theta$ .

Let  $\theta > 1$  be the positive root of  $x^3 - x - 1$ . The other roots  $\theta'$  and  $\bar{\theta}'$  are complex numbers of modulus  $1/\sqrt{\theta}$ . For a later application, let us consider the intersection of the negative real line with the set in the complex plane  $\mathbb{C}$  defined

by

$$(3.1) \quad \mathcal{T} = \left\{ \sum_{i=4}^{\infty} a_i (\theta')^i \mid a_i \in \{0, 1\} \quad \text{and} \quad \sum_{k=0}^4 a_{i+k} \leq 1 \quad \text{for each} \quad i \geq 4 \right\}.$$

It is easy to confirm that  $\mathcal{T}$  satisfies the set equation

$$\mathcal{T} = \theta' \mathcal{T} \cup ((\theta')^5 \mathcal{T} + \theta'^5),$$

and this set equation conversely characterizes the set  $\mathcal{T}$ . The boundary  $\partial\mathcal{T}$  of  $\mathcal{T}$  is shown in Figure 5.

In Akiyama-Sadahiro [8] it is proved that the origin 0 is an inner point of  $\mathcal{T}$  and its boundary is completely described as the union of 5 self similar sets.<sup>2</sup> Let  $\gamma$  be the supremum such that  $[-\gamma, 0]$  is contained in  $\mathcal{T}$ . The next theorem is merely a computational result.

**Theorem 3.1.**  $\gamma = 0.666666666608644067488 \dots$

**Remark 3.2.** The readers will ask why  $\gamma$  is so close to  $2/3$ . We do not have a sufficient answer but just note that  $-2/3$  is on the boundary of  $\mathcal{T}$ . Taking a closer look to the intersection of  $\mathcal{T}$  and the negative real line, a similar phenomenon is seen around  $3/4$ .

*Proof.* Unfortunately the procedure is beyond hand calculation. To read this proof, Figure 6 will be helpful. Since the origin 0 is an inner point of  $\mathcal{T}$ , we see  $\gamma > 0$ . The boundary of  $\mathcal{T}$  is given as the union of 5 self similar sets and we need to calculate the smallest positive  $\gamma$  that  $-\gamma \in \partial\mathcal{T}$ . We shall give the idea how we can make an algorithm to calculate the intersection.

In order to approximate  $\gamma$ , let us introduce an approximation of  $\partial\mathcal{T}$  by broken lines. By [8], the 5 points  $\{-(\theta')^j \mid j = 0, 1, 2, 3, 4\}$  are in  $\partial\mathcal{T}$ . Consider  $\partial\mathcal{T}$  to be partitioned into five curve segments:

- $\mathcal{E}_1$  be the segment connecting  $-(\theta')^2$  and  $-(\theta')^4$ ,
- $\mathcal{E}_2$  be the segment connecting  $-(\theta')^4$  and  $-\theta'$ ,
- $\mathcal{E}_3$  be the segment connecting  $-\theta'$  and  $-(\theta')^3$ ,
- $\mathcal{E}_4$  be the segment connecting  $-(\theta')^3$  and  $-1$ ,
- $\mathcal{E}_5$  be the segment connecting  $-1$  and  $-(\theta')^2$ .

Then by [8, Theorem 4.], the  $\mathcal{E}_i$  satisfy the set equations:

- $\mathcal{E}_1 = ((\theta')^5 \mathcal{E}_1 + (\theta')^6) \cup ((\theta')^4 \mathcal{E}_1 + (\theta')^3)$ ,
- $\mathcal{E}_2 = ((\theta')^5 \mathcal{E}_2 + (\theta')^5) \cup ((\theta')^4 \mathcal{E}_2 + 1)$ ,
- $\mathcal{E}_3 = ((\theta')^5 \mathcal{E}_3 + (\theta')^5) \cup ((\theta')^4 \mathcal{E}_3 + (\theta')^2)$ ,
- $\mathcal{E}_4 = ((\theta')^5 \mathcal{E}_4 + (\theta')^4) \cup ((\theta')^4 \mathcal{E}_4 + (\theta')^{-1})$ ,
- $\mathcal{E}_5 = ((\theta')^5 \mathcal{E}_5 + (\theta')^4) \cup ((\theta')^4 \mathcal{E}_5 + \theta')$ .

---

<sup>2</sup>More precisely, they gave the description of the boundary of  $\theta'^{-4}\mathcal{T}$  in [8]. In their notation,  $\mathcal{T} = \mathcal{K}_{0000}$ .

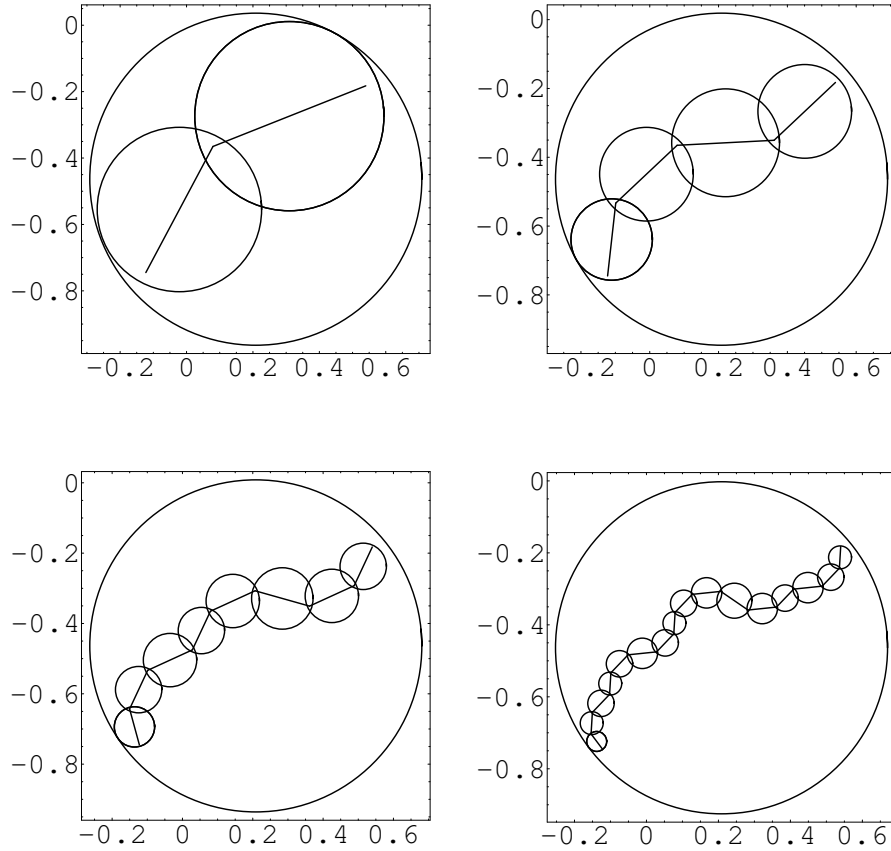
FIGURE 7. The encircling algorithm for  $\mathcal{E}_1$ .

Note that the  $\mathcal{E}_i$  are similar to each other whereas each  $\mathcal{E}_i$  is a self affine set. Therefore  $\mathcal{T}$  is a graph directed self affine set with

$$\mathcal{T} = \bigcup_{i=1}^5 \mathcal{E}_i.$$

Let  $\mathcal{E}_1^{(0)}$  be the line connecting  $-(\theta')^4$  and  $-\theta'$ . Define inductively

$$\mathcal{E}_1^{(n+1)} = ((\theta')^5 \mathcal{E}_1^{(n)} + (\theta')^6) \cup ((\theta')^4 \mathcal{E}_1^{(n)} + (\theta')^3)$$

for  $n \geq 1$  and define analogously  $\mathcal{E}_i^{(n)}$  for  $i = 2, \dots, 5$ .

Denote by  $V(\mathcal{E}_i^{(n)})$  the set of vertices of  $\mathcal{E}_i^{(n)}$ . Then we see  $V(\mathcal{E}_i^{(n+1)}) \supset V(\mathcal{E}_i^{(n)})$ . Thus  $\mathcal{E}_i^{(n)}$  is a broken line. Therefore, each segment of  $\mathcal{E}_i^{(n)}$  grows into a shrunked copy of  $\mathcal{E}_1$  as  $n \rightarrow \infty$ .

Following [8], we introduce the idea of so called encircling disks. One can find a positive number  $r$  such that each  $\mathcal{E}_i$  is entirely contained in the disk centered at the middle point of two end points and of radius

$$r/2 \times (\text{length of } \mathcal{E}_i^{(0)}).$$

As the  $\mathcal{E}_i$  are similar to each other, this  $r$  can be taken independent on the choice of  $i$ . A small  $r$  is of course preferred. First take a sufficiently large  $r$ , e.g.,

$$r = \frac{2|\beta'|^4}{(1 - |\beta'|)(1 - (\beta')^4 + (\beta')^2)} = 10.00076,$$

since  $\mathcal{E}_1$  is contained in  $\mathcal{T}$ . For example, write the encircling disk for each segment of  $\mathcal{E}_1(3)$  by this  $r$ . Then we see that  $r$  can be replaced by  $r = 2.5$ . Repeating this process, one can take  $r = 1.03$  by using  $\mathcal{E}_1(7)$ . The first four such steps are shown in Figure 7.

Observe that the encircling disk with  $r = 1.03$ ,  $\mathcal{E}_1, \mathcal{E}_2, \mathcal{E}_3$  can not have any intersection with the negative real axis. Thus we need to consider  $\mathcal{E}_4$  and  $\mathcal{E}_5$ . Let us do the same for  $\mathcal{E}_4(n)$  and  $\mathcal{E}_5(n)$  for  $n = 1, 2, \dots$ . There are line segments of  $\mathcal{E}_i(n)$  ( $i = 4, 5$ ) which do not have any ‘potential possibility’ to hit the negative real line. Thus we abandon them. Repeating this procedure by computer, for each  $n$  there remains a set of small segments. Each of such segments, we write the corresponding encircling disks. Then we get an estimation of  $-\gamma$ .  $\square$

**Remark 3.3.** In this example, we have precise information on the boundary of  $\mathcal{T}$ . Usually, it is not a difficult task to obtain such information by using automata (cf. [17, 22, 42, 43]).

Thus for a pretty large class of tiles, we can do the same type of approximation. It is quite likely that the intersection of such a tile with the negative real line has infinitely many components but we could not prove it at present.

**Remark 3.4.** Recently J. Luo [31] showed that the boundary  $\partial\mathcal{T}$  is a Jordan closed curve.

**3.2. Purely periodic orbits of  $\beta$ -expansions.** Let  $\beta > 1$  be a fixed real number and define the map  $T_\beta : [0, 1) \rightarrow [0, 1)$  by  $x \rightarrow \beta x - \lfloor \beta x \rfloor$ . For each  $\xi \in [0, 1)$  we write:

$$\xi \xrightarrow{a_1} T_\beta(\xi) \xrightarrow{a_2} T_\beta^2(\xi) \xrightarrow{a_3} T_\beta^3(\xi) \xrightarrow{a_4} \dots$$

where  $a_i = \lfloor T_\beta^{i-1}(\xi) \rfloor$ . This algorithm yields an expansion of  $\xi$  of the form

$$\xi = \frac{a_1}{\beta} + \frac{a_2}{\beta^2} + \frac{a_3}{\beta^3} + \dots,$$

which gives a generalization of the usual decimal or binary system to the real base  $\beta$  with digits  $[0, \beta) \cap \mathbb{Z}$ . Again, we will use the notation introduced in Remark 2.4. As for any positive  $\xi$  there is an integer  $N$ , such that  $\beta^{-N}\xi \in [0, 1)$ , we have in a similar manner

$$\xi = a_{-N}a_{-N+1} \dots a_{-1}a_0.a_1a_2a_3 \dots$$



This is called the  $\beta$ -*expansion* of  $\xi$  and its ergodic properties have been well studied, for example, in [24, 35, 36]. Formally we consider

$$1 \xrightarrow{c_1} T_\beta(1) \xrightarrow{c_2} T_\beta^2(1) \xrightarrow{c_3} T_\beta^3(1) \xrightarrow{c_4} \dots$$

and

$$1 = \frac{c_1}{\beta} + \frac{c_2}{\beta^2} + \frac{c_3}{\beta^3} + \dots$$

It is shown in [35], that a formal finite expansion by letters  $[0, \beta) \cap \mathbb{Z}$  is realized by the  $\beta$ -expansion algorithm, if and only if it is less than the bi-infinite word  $c_1 c_2 c_3 \dots$  at any starting point by its natural lexicographical order. This  $c_1 c_2 c_3 \dots$  is called the *expansion of 1*. We say that the  $\beta$ -expansion is *finite* when  $a_i = 0$  for all sufficiently large  $i$ .

The closure of the set of infinite sequences occurring as  $\beta$ -expansions is called  $\beta$ -shift. The  $\beta$ -shift is called of finite type if and only if the set of all finite factors is defined by the interdiction of a finite set of words. It is called sofic if and only if the set of finite factors is recognized by a finite automaton. In [13], it is proved, that the  $\beta$ -shift is of finite type if and only if the  $\beta$ -expansion of 1 is finite, i.e. if and only if  $T_\beta^k(1) = 0$  for some  $k \geq 0$ . The  $\beta$ -shift is sofic if and only if the  $\beta$ -expansion of 1 is eventually periodic i.e. if and only if the orbit  $\{T_\beta^k(1)\}_{k=0}^\infty$  is finite.

Denote by  $\text{Fin}(\beta)$  the set of  $x \geq 0$  having finite  $\beta$ -expansions. It is a subset of  $\text{Per}(\beta)$ , the set of numbers having eventually periodic  $\beta$ -expansions. When  $\beta$  has the finiteness property

$$(F) \quad \text{Fin}(\beta) = \mathbb{Z}[\beta^{-1}] \cap \mathbb{R}_+,$$

then this number system has striking analogies to the usual number systems with positive integer base  $\geq 2$  (cf. [1, 19]).

It is proved in [12, 40], that if  $\beta$  is a Pisot number, then  $\text{Per}(\beta) = \mathbb{Q}(\beta) \cap \mathbb{R}_+$ . Conversely, in [40], it is proved, that if  $\mathbb{Q} \cap [0, 1] \subset \text{Per}(\beta)$ , then  $\beta$  is a Pisot or a Salem number. A sufficient (but not necessary) condition for (F) has been proved in [19]: Let  $\beta$  be the positive root of the polynomial  $x^m - b_1 x^{m-1} - \dots - b_m$  with  $b_i \in \mathbb{Z}$ ,  $b_1 \geq b_2 \geq \dots \geq b_m > 0$ . Then  $\beta$  is a Pisot number (which follows from a theorem of Brauer [14]), the  $\beta$ -shift is a system of finite type and  $\beta$  fulfills (F).

The minimal Pisot number  $\theta$ , treated in subsection 3.1, satisfies property (F). The expansion of one is given by  $1 = .10001$ . This means, that the words 11, 101, 1001 and 10001 are forbidden in expansions with base  $\theta$ . Therefore, the corresponding shift space is of finite type.

Furthermore, since  $\theta$  is a unit, we have  $\mathbb{Z}[\theta^{-1}] = \mathbb{Z}[\theta]$ . It was shown in [1] that all sufficiently small rational numbers have purely periodic orbits by  $T_\theta$ . This result yields an analogy to Theorem 2.2. It is interesting to calculate the supremum  $\kappa > 0$  such that each rational number less than  $\kappa$  has a purely periodic expansion. Claim 1 in [1] says  $0.4342 < \kappa < 0.6924$ . Here we show that

**Theorem 3.5.**  $\gamma \leq \kappa$  and we have  $\kappa = 0.666666666608644067488 \dots$

**Remark 3.6.** It is quite likely that  $\kappa = \gamma$ . However at present, we can not prove this equality. We can not remove the possibility that the intersection of the real line with  $\partial\mathcal{T}$  is a ‘small’ set, for example a single irrational point, in the neighborhood of  $\gamma$ .

Before giving a proof, it may be convenient for the reader to recall a tiling of  $\mathbb{C}$ , which was originally defined by W. P. Thurston [41] in the notion of [2]. Roughly speaking, the tiling is defined by classifying the fractional parts  $.a_1a_2 \dots a_M$  of the elements  $\text{Fin}(\theta)$  and mapping these parts to  $\mathbb{C}$  by using the conjugates of  $\theta$ . More precisely, define

$$\mathcal{K}_{.a_1 \dots a_M} = \left\{ \overline{\left\{ \sum_{i=1}^M a_i(\theta')^{-i} + \sum_{i=-N}^0 c_i(\theta')^{-i} \mid c_{-N}c_{-N+1} \dots c_0.a_1 \dots a_M \in \text{Fin}(\theta) \right\}} \right\},$$

which gives a tile, corresponding to the fractional part  $.a_1a_2 \dots a_M$ . Note that all these sums are well defined since  $|\theta'| < 1$ .

The symbol  $\mathcal{K}_{.}$  corresponds to the elements of  $\text{Fin}(\theta)$  without fractional parts. It was shown in [8, Lemma 2.] that

$$(3.2) \quad \mathbb{C} = \bigcup_{.a_1 \dots a_M} \mathcal{K}_{.a_1 \dots a_M},$$

and this gives a tiling of  $\mathbb{C}$ , in the sense that there are 5 different tiles up to translation. The intersection of two different tiles has measure zero. We define  $\mathcal{K}_{a_{-N} \dots a_0.a_1 \dots a_M}$  in a similar manner which has corresponding restriction on ‘integer parts’. Now we see that  $\mathcal{K}_{0000.} = \mathcal{T}$ , since in (3.1), the summation starts with  $i = 4$ . In [2, Theorem 2.], it is proved, that each element of  $\text{Fin}(\theta)$  corresponds to an inner point of the tile.

*Proof.* First we show  $\gamma \leq \kappa$ . It suffices to show that a rational number  $\xi$  in  $[0, \gamma)$  has purely periodic expansion. Take coprime positive integers  $p, q$  such that  $\xi = p/q$ . As  $\theta \pmod{q\mathbb{Z}[\theta]}$  is a unit in the finite ring  $\mathbb{Z}[\theta]/q\mathbb{Z}[\theta]$ , there is a positive integer  $m$  such that  $(\theta^m - 1)\xi = ((\theta^m - 1)/q)q\xi \in \mathbb{Z}[\theta]$ . Note that we can replace  $m$  by its multiples. By property (F), we have  $(\theta^m - 1)\xi = a_{-N}a_{-N+1} \dots a_{-1}a_0.a_1a_2 \dots a_M$  for some integers  $N$  and  $M$ . By Theorem 2 of [2],  $(\theta^m - 1)\xi'$  is an inner point of  $\mathcal{K}_{a_{-3}a_{-2}a_{-1}a_0.a_1 \dots a_M}$ . Note that  $\xi = \xi'$  as  $\xi \in \mathbb{Q}$ . Thus taking  $m$  large enough, then  $(\theta^m - 1)\xi'$  can be taken arbitrary close to  $-\xi$  which lies in the interior of  $\mathcal{T} = \mathcal{K}_{0000.}$ . Considering the subdivided tiling, we see that  $a_{-3}a_{-2}a_{-1}a_0.a_1 \dots a_M = 0000.$  must hold, since the interior of two different tiles can not have any intersection. On the other hand, as  $\xi < 1$ , we have  $N < m$ . Thus we have

$$(\theta^m - 1)\xi = a_{-N}a_{-N+1} \dots a_{-5}a_{-4}0000.$$

This shows

$$\xi = .[a_{-N}a_{-N+1} \dots a_{-4}0000]^\infty$$

which indeed gives a greedy expansion.

Secondary we describe how to reach the estimate of  $\kappa$ . This is done by a similar procedure as we did to get the one of  $\gamma$ . Assume that an interval  $(-c, -c + \epsilon) \subset (-1/\theta, 0]$  with  $\epsilon > 0$ , which does not intersect with  $\mathcal{T}$ . Then  $(-c, -c + \epsilon)$  is contained in  $\mathcal{K}_{10}$ , which can be shown by the encircling method (see figure 6 of [8] again). On the other hand we have  $c > \gamma$  by Theorem 3.1. Take  $\xi \in (c - \epsilon, c) \cap \mathbb{Q}$ . Then  $\xi$  has the  $\beta$ -expansion  $\xi = 0.k_1k_2\dots$  with  $k_1 = 0$  and  $k_2 = 1$ . We wish to show that  $\kappa \leq c$ . It is enough to show that  $\xi$  is not purely periodic. Assuming the contrary, we have a  $\beta$ -expansion:

$$\xi = .[k_1k_2\dots k_\ell]^\infty = \frac{\sum_{i=1}^{\ell} k_i\theta^{-i}}{1 - \theta^{-\ell}}.$$

We may assume that  $\ell$  is sufficiently large since it can be replaced by its multiples. Therefore

$$\xi = \frac{\sum_{i=1}^{\ell} k_i\theta^{\ell-i}}{\theta^\ell - 1}.$$

and we may assume that  $-\xi$  is contained in the interior of  $\mathcal{K}_{10}$ . This shows that  $k_{\ell-1} = 1$  and  $k_\ell = 0$ . This gives a contradiction since  $.k_1k_2\dots k_{\ell-1}k_\ell k_1k_2\dots$  is not admissible. Summing up, we have seen that  $\kappa \leq c$ . Thus we can estimate  $\kappa$  by finding such intervals  $(-c, -c + \epsilon)$  outside  $\mathcal{T}$ .  $\square$

**3.3. Connected components of  $\mathcal{T} \cap \mathbb{R}$ .** Let  $\theta$ ,  $\theta'$  and  $\bar{\theta}'$  be defined as in subsection 3.1. The identity (3.2) can be written as

$$\mathbb{C} = \bigcup_{\omega \in \mathbb{Z}[\theta] \cap [0,1)} \mathcal{K}_\omega,$$

since each number of  $[0, 1)$  can be expanded with digits only on the right side of the decimal point. Therefore, also the numbers of  $\mathbb{Z}[\theta] \cap [0, 1)$  must have such expansions.

Now take  $\tilde{\omega} \in \mathbb{Z}[\theta] \cap [0, \theta^4)$ . Then

$$\tilde{\omega} = a_{-3} \dots a_0.a_1 \dots a_M$$

with  $a_{-3} + \dots + a_0 \leq 1$ . Since

$$\tilde{\omega}' \in \mathcal{K}_{a_{-3}\dots a_0.a_1\dots a_M} \subset \mathcal{K}_{.a_1\dots a_M},$$

the above tiling can be subdivided to

$$\mathbb{C} = \bigcup_{\tilde{\omega} \in \mathbb{Z}[\theta] \cap [0, \theta^4)} \mathcal{K}_{\tilde{\omega}}.$$

Define

$$f(x) = (\theta')^5(x + 1) - 1.$$

Then  $-1 = f(-1)$  is a fixed point of  $f(\cdot)$ . Therefore,  $f(\cdot)$  is locally a rotation around  $-1$ , together with a contraction.

**Lemma 3.7.**  $-1$  is a multiple point of the subdivided tiles, that is,

$$-1 \in \mathcal{K}_{0000.} \cap \mathcal{K}_{00000.0001} \cap \mathcal{K}_{0000010.} \cap \mathcal{K}_{000000.1} \cap \mathcal{K}_{00000100.0001}.$$

Moreover above five subdivided tiles are invariant under  $f$ .

*Proof.* In the following, we will use the notation  $\bar{1} := -1$ .

Since  $1 = .011$  and  $1 = .10001$ , we have two possibilities to deal with carries. We get two different expansions of zero:  $0 = \bar{1}011$  and  $0 = \bar{1}10001$ . As one can see from the addition in (3.3),  $\bar{1}$  can be expanded to a one sided infinite sequence:

$$(3.3) \quad \begin{array}{r} \bar{1}. \\ \bar{1}10001. \\ \bar{1}10001 \\ \bar{1}10001 \\ \dots\dots 1 \\ \hline \dots\dots 0100001000010000. \end{array}$$

This sequence converges since  $|\theta'| < 1$ . Therefore

$$\bar{1}. \in \mathcal{K}_{0000.}.$$

Take  $z \in \mathcal{K}_{0000.}$  with the expansion

$$z = \sum_{i=0}^{\infty} a_{-i}(\theta')^i \quad \text{with } a_0 = a_{-1} = a_{-2} = a_{-3} = 0.$$

Write formally  $z = \dots 0000$ . Applying  $f$ , the similar computation yields

$$f(z) = (\theta')^5(z + 1) - 1 = \dots 00010000\bar{1}. = \dots 000010000.$$

As we find four consecutive 0's in front of 1, this new expansion is also admissible. This implies  $f(\mathcal{K}_{0000.}) \subset \mathcal{K}_{0000.}$ . Other statements are shown in the similar manner.  $\square$

**Lemma 3.8.** Let  $\theta' = |\theta'| \exp(\sqrt{-1}\varphi)$ . Then  $\frac{\varphi}{\pi} \in \mathbb{R} \setminus \mathbb{Q}$ .

*Proof.* Assume that  $\frac{\varphi}{\pi} \in \mathbb{Q}$ . Then there exists a  $m > 1$  such that  $\theta'^m = \bar{\theta}'^m \in \mathbb{R}$ . This shows that  $[\mathbb{Q}(\theta) : \mathbb{Q}(\theta^m)] = 1$ , which implies  $\theta^m = \gamma \in \mathbb{Q}$ . Thus the conjugates of  $\theta$  must be a root of the polynomial  $X^m - \gamma$ . This shows that all conjugates of  $\theta$  must have the same absolute value. This is a contradiction.  $\square$

We know that  $\mathcal{K}_{0000.}$  contains a closed disk  $D$  with center 0 and radius  $r < 1$ . Let  $\eta$  be the angle between the real axis and the tangent from  $-1$  to  $D$  (cf. Fig. 8.). Since  $\frac{\varphi}{\pi} \notin \mathbb{Q}$ , the sequence  $\{\frac{5n\varphi}{2\pi}\}_{n=1}^{\infty}$  is dense in  $[0, 1)$ . Therefore, there is an increasing sequence  $\{n_j\}$  of positive integers, such that

$$\left\| \frac{5n_j\varphi}{2\pi} \right\| < \frac{\eta}{2\pi}$$

for all  $j$ . Thus, the angle of the rotation performed by  $f^{n_j}(\cdot)$  is less than  $\eta$ . Then  $f^{n_j}(D)$  must intersect the real line, which gives a closed interval  $I_j$ . This gives

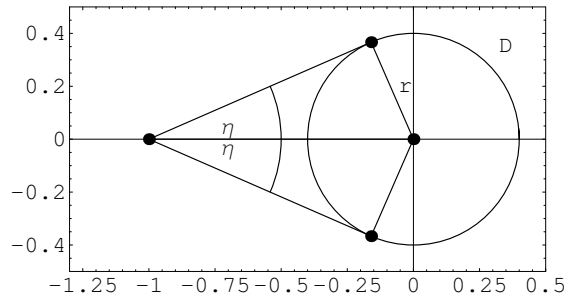

FIGURE 8.

infinitely many intervals  $I_j$  converging to  $-1$  in  $[-1, 0] \cap K_{0000}$ . Switching to a subsequence of  $\{n_j\}$ , we may assume that all  $I_j$  are disjoint.

The same argument for  $K_{000000.1}$  gives infinitely many disjoint intervals  $J_j$  in  $[-1, 0]$  converging to  $-1$  located outside of  $K_{0000}$ . Here we used the fact that the intersection of two tiles has zero measure. Thus we have shown:

**Theorem 3.9.** *There exists a real strictly decreasing sequence  $\{a_i\}_{i=0,1,\dots}$  converging to  $-1$  so that  $[a_{4i}, a_{4i+1}] \subset \mathcal{T}$  and  $[a_{4i+2}, a_{4i+3}] \subset \mathbb{C} \setminus \mathcal{T}$  for  $i = 0, 1, \dots$ . In particular,  $\mathcal{T} \cap \mathbb{R}$  has infinitely many connected components.*

Following the proof of Theorem 3.5, we have

**Theorem 3.10.** *There exists a real strictly increasing sequence  $\{a_i\}_{i=0,1,\dots}$  converging to  $1$  so that for a point  $x \in \mathbb{Q} \cap [0, 1]$  if  $x \in [a_{4i}, a_{4i+1}]$  then  $x$  has purely periodic beta expansion and if  $x \in [a_{4i+2}, a_{4i+3}]$  then  $x$  does not have a purely periodic expansion.*

## REFERENCES

- [1] S. Akiyama, *Pisot numbers and greedy algorithm*, Number Theory, Diophantine, Computational and Algebraic Aspects (A. Pethő K. Györy and V. T. Sós, eds.), de Gruyter, 1998, pp. 9–21.
- [2] ———, *Self affine tilings and Pisot numeration systems*, Number Theory and its Applications (K. Györy and S. Kanemitsu, eds.), Kluwer, 1999, pp. 1–17.
- [3] S. Akiyama, T. Borbély, H. Brunotte, A. Pethő, and J. M. Thuswaldner, *On a generalization of the radix representation - a survey*, High Primes and Misdemeanours: lectures in honour of the 60th birthday of Hugh Cowie Williams (to appear).
- [4] S. Akiyama, H. Brunotte, and A. Pethő, *Cubic CNS polynomials, notes on a conjecture of W.J. Gilbert*, J. Math. Anal. Appl. (to appear).
- [5] S. Akiyama, J. Luo, and J. M. Thuswaldner, *On the boundary connectedness of connected tiles*, Math. Proc. Camb. Philos. Soc. (to appear).
- [6] S. Akiyama and A. Pethő, *On canonical number systems*, Theor. Comput. Sci. **270(1-2)** (2002), 921–933.
- [7] S. Akiyama and H. Rao, *New criteria for canonical number systems*, Acta Arith. (to appear).
- [8] S. Akiyama and T. Sadahiro, *A self-similar tiling generated by the minimal Pisot number*, Acta Math. Info. Univ. Ostraviensis **6** (1998), 9–26.

- [9] S. Akiyama and J. M. Thuswaldner, *On the Topological Structure of Fractal Tilings generated by Quadratic Number Systems*, submitted.
- [10] ———, *Topological Properties of Two-dimensional Number Systems*, J. Théor. Nombres Bordeaux **12** (2000), 69–79.
- [11] J. Berstel, *Transductions and context-free languages*, Teubner, 1979.
- [12] A. Bertrand, *Développements en base de pisot et répartition modulo 1*, C. r. Acad. Sci. Sér. A. **285** (1977), 419–421.
- [13] F. Blanchard,  *$\beta$ -expansions and symbolic dynamics*, Theoret. Comput. Sci. **65** (1989), 131–141.
- [14] A. Brauer, *On algebraic equations with all but one root in the interior of the unit circle*, Math. Nachr. **4** (1951), 250–257.
- [15] H. Brunotte, *On Trinomial Bases of Radix Representations of Algebraic Integers*, Acta Sci. Math. (Szeged) **67** (2001), 553–559.
- [16] ———, *Characterization of CNS Trinomials*, Acta Sci. Math. (Szeged) **68** (2002), 673–679.
- [17] P. Duvall, J. Keesling, and A. Vince, *The Hausdorff dimension of the boundary of a self-similar tile*, J. London Math. Soc. (2) **61** (2000), 748–760.
- [18] S. Eilenberg, *Automata, languages and machines*, Academic Press, New York, 1974.
- [19] Ch. Frougny and B. Solomyak, *Finite beta-expansions*, Ergodic Theory Dynamical Systems **12** (1992), 45–82.
- [20] W. J. Gilbert, *Radix representations of quadratic number fields.*, J. Math. Anal. Appl. **83** (1981), 263–274.
- [21] P. J. Grabner, P. Kirschenhofer, and H. Prodinger, *The sum-of-digits-function for complex bases*, J. London Math. Soc. **57** (1998), no. 1, 20–40.
- [22] K. Gröchenig and A. Haas, *Self-similar lattice tilings*, J. Fourier Anal. Appl. **1** (1994), 131–170.
- [23] G. H. Hardy and E. M. Wright, *An introduction to the theory of numbers*, 5th ed., Clarendon Press, Oxford, 1979.
- [24] S. Ito and Y. Takahashi, *Markov subshifts and realization of  $\beta$ -expansions*, J. Math. Soc. Japan **26** (1974), 33–55.
- [25] I. Kátai and I. Kőrnyci, *On number systems in algebraic number fields*, Publ. Math. Debrecen **41** (1992), no. 3–4, 289–294.
- [26] I. Kátai and B. Kovács, *Kanonische Zahlensysteme in der Theorie der Quadratischen Zahlen*, Acta Sci. Math. (Szeged) **42** (1980), 99–107.
- [27] ———, *Canonical number systems in imaginary quadratic fields*, Acta Math. Hungar. **37** (1981), 159–164.
- [28] I. Kátai and J. Szabó, *Canonical number systems for complex integers*, Acta Sci. Math. (Szeged) **37** (1975), 255–260.
- [29] B. Kovács and A. Pethő, *Number systems in integral domains, especially in orders of algebraic number fields*, Acta Sci. Math. (Szeged) **55** (1991), 286–299.
- [30] M. Lothaire, *Algebraic combinatorics on words*, Encyclopedia of Mathematics and its Applications, vol. 90, Cambridge University Press, Cambridge, 2002.
- [31] J. Luo, *A note on a self-similar tiling generated by the minimal Pisot number*, Fractals **10** (2002), no. 3, 335–339.
- [32] B. B. Mandelbrot, *The fractal geometry of nature*, W. H. Freeman and Co., San Francisco, Calif., 1982.
- [33] J. M. Marstrand, *Some fundamental geometrical properties of plane sets of fractional dimensions*, Proc. London Math. Soc. (3) **4** (1954), 257–302. MR 16,121g
- [34] W. Müller, J. M. Thuswaldner, and R. F. Tichy, *Fractal properties of number systems*, Periodica Math. Hungar. **42** (2001), 51–68.

- [35] W. Parry, *On the  $\beta$ -expansion of real numbers*, Acta Math. Acad. Sci. Hungar. **11** (1960), 401–416.
- [36] A. Renyi, *Representations for reals numbers and the ergodic properties*, Acta Math. Hungar. **8** (1957), 477–493.
- [37] K. Scheicher and J.M. Thuswaldner, *Canonical Number Systems, Counting Automata and Fractals*, Math. Proc. Camb. Philos. Soc. **133** (2002), 163–182.
- [38] ———, *Neighbours of Self-affine Tiles in Lattice Tilings*, Trends in Mathematics: Fractals in Graz 2001, Birkhäuser, 2002, pp. 241–262.
- [39] ———, *On the Characterization of Canonical Number Systems*, Osaka J. Math. (to appear).
- [40] K. Schmidt, *On periodic expansions of Pisot numbers and Salem numbers*, Bull. London Math. Soc. **12** (1980), 269–278.
- [41] W. Thurston, *Groups, tilings and finite state automata*, AMS Colloquium Lecture Notes, 1989.
- [42] A. Vince, *Digit tiling of euclidean space*, ch. Directions in Mathematical Quasicrystals, pp. 329–370, 2000.
- [43] Y. Wang, *Self-affine tiles*, Advances in Wavelet (K. S. Lau, ed.), Springer, 1998, pp. 261–285.

DEPARTMENT OF MATHEMATICS, FACULTY OF SCIENCE, NIIGATA UNIVERSITY, IKARASHI  
2-8050, NIIGATA 950-2181, JAPAN

*E-mail address:* akiyama@math.sc.niigata-u.ac.jp

JOHANN RADON INSTITUTE FOR COMPUTATIONAL AND APPLIED MATHEMATICS (RI-  
CAM), AUSTRIAN ACADEMY OF SCIENCES, ALTENBERGERSTRASSE 69, A-4040 LINZ, AUSTRIA

*E-mail address:* klaus.scheicher@oeaw.ac.at